

THIS DRAWING IS THE PROPERTY OF ANALOG DEVICES INC. IT IS NOT TO BE REPRODUCED OR COPIED, IN WHOLE OR IN PART, OR USED IN FURNISHING INFORMATION TO OTHERS, OR FOR ANY OTHER PURPOSE DETRIMENTAL TO THE INTERESTS OF ANALOG DEVICES. THE EQUIPMENT SHOWN HEREON MAY BE PROTECTED BY PATENTS OWNED OR CONTROLLED BY ANALOG DEVICES.

RELAY CONTROL CHART

CONTROL	CODE	DEVICE	FUNCTION	CONNECTOR

JUMPER TABLE		
JP#	ON	OFF
1		
2		
3		
4		
5		

* SEE ASSEMBLY INSTRUCTIONS

REVISIONS			
REV	DESCRIPTION	DATE	APPROVED
A	INITIAL RELEASE	21FEB19	J.NASO
B	CHANGES AS PER ECR-056628	07JUL19	J.NASO

TEMPLATE ENGINEER -	DATE	SCHEMATIC 			
HARDWARE SERVICES -					
HARDWARE SYSTEMS -					
TEST ENGINEER -					
COMPONENT ENGINEER -					
TEST PROCESS -					
HARDWARE RELEASE -		HW TYPE : Customer Evaluation - Z Product(s) : LTC4317 : LTC4316 LTC4318 PACKAGE : N/A-lead N/A N/A-family : Pitch-pitch StyleVendor Style <User Define> <User Define> <User Define>			
DESIGNER R. ALAWAS	21FEB19	MASTER PROJECT TEMPLATE TBD	TESTER TEMPLATE no_template	DRAWING NO. 02_056628	REV. B
PTD ENGINEER J. NASO	21FEB19	<small>UNLESS OTHERWISE SPECIFIED DIMENSIONS ARE IN INCHES</small> TOLERANCES DECIMALS X.XX +0.010 FRACTIONS +1/32 ANGLES +2 X.XXX +0.005		SIZE D	SCALE 1:1
CHECKER -				CODE ID NO. CodeID	SHEET 1 OF 2

P.O SPEC.	BK/BD SPEC.	SOCKET OEM	OEM PART#	HANDLER

REVISIONS			
REV	DESCRIPTION	DATE	APPROVED

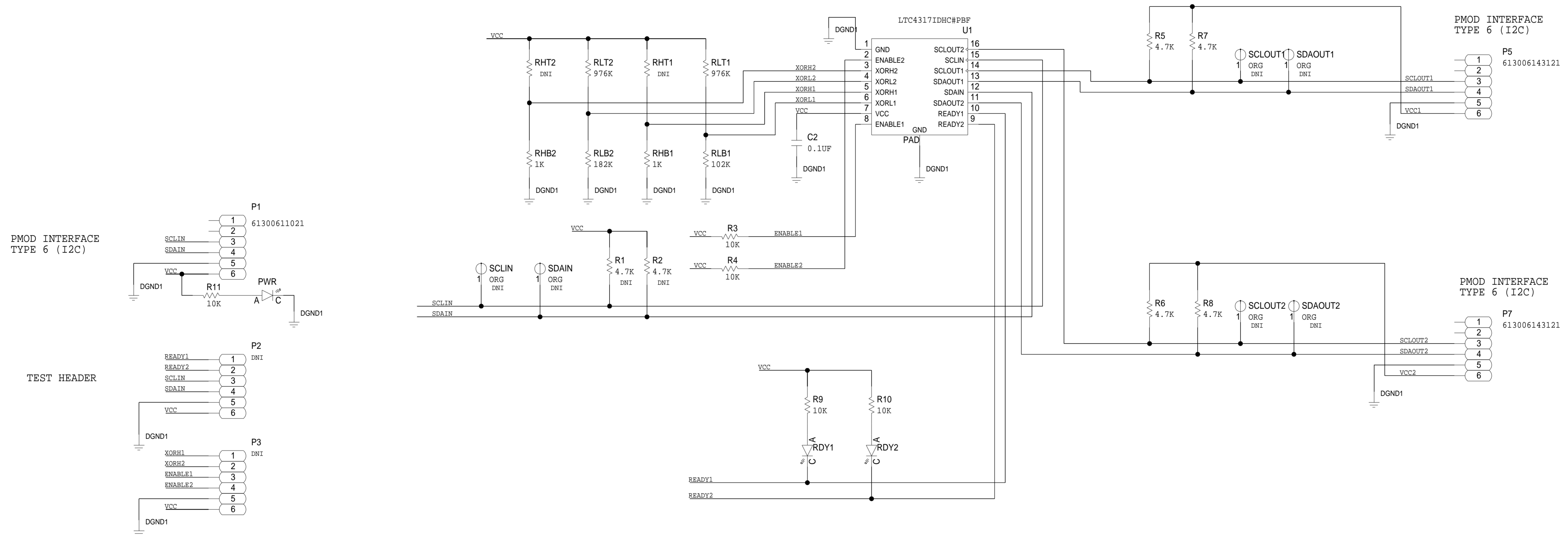

PMOD INTERFACE
TYPE 6 (I2C)

PMOD INTERFACE
TYPE 6 (I2C)

PMOD INTERFACE
TYPE 6 (I2C)

TEST HEADER

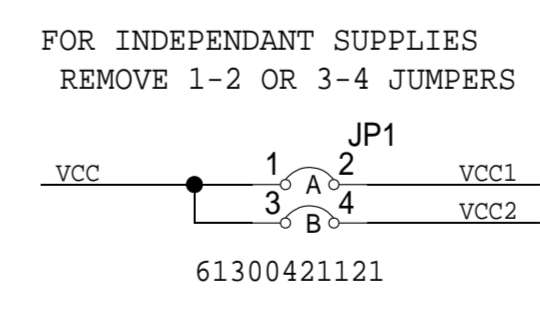
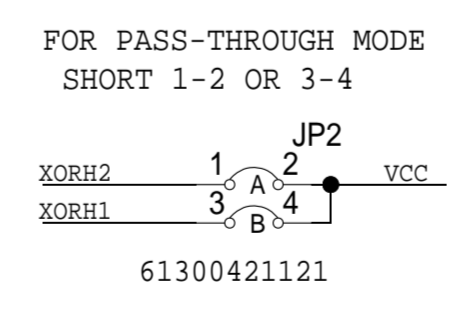
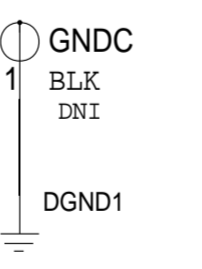
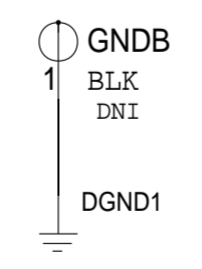
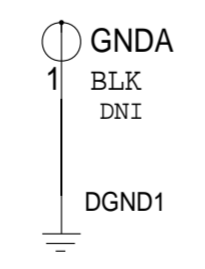

	SCHEMATIC		
	HW TYPE : Customer Evaluation - Z Product(s) : LTC4317 : LTC4316 LTC4318		
DESIGN VIEW <DESIGN_VIEW>	DRAWING NO. 02_056628	REV B	
PTD ENGINEER J. NASO	SIZE D	SCALE 1:1	SHEET 2 OF 2

THIS DRAWING IS THE PROPERTY OF ANALOG DEVICES INC. IT IS NOT TO BE REPRODUCED OR COPIED IN WHOLE OR IN PART, OR USED IN ANY MANNER FOR THE INTERESTS OF ANALOG DEVICES. THE EQUIPMENT SHOWN HEREIN MAY BE PROTECTED BY PATENTS OWNED OR CONTROLLED BY ANALOG DEVICES.